

Article number: 07158056001

Description: Universal joint single 0.158.056.001
S=200 X= Bore with keyway

Measures

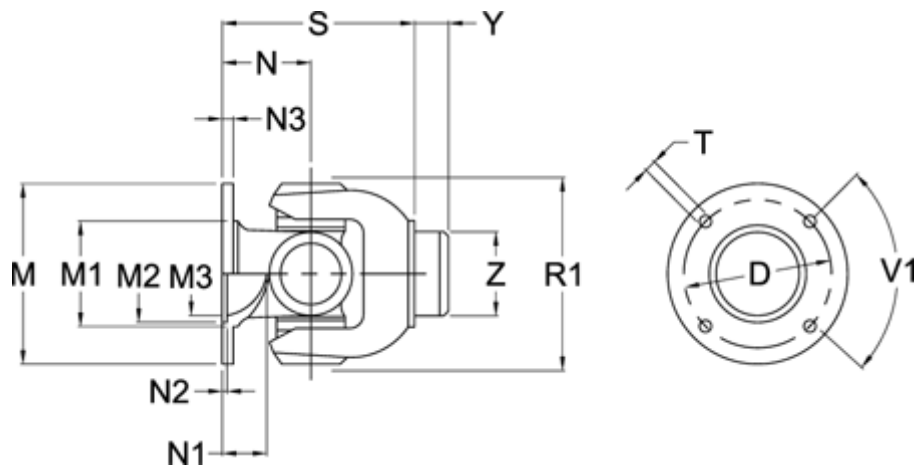

D	= 155,5 \pm 0,1	N2	= 3,6 \pm 0,5	Z = 82.25
Flange diameter M	= 180	N3	= 12	
M1	= 126	Number of Flangeholes	= 8	
M2	= 110	R1	= 150	
M3	= 100	S min	= 200	
Max. Bending Angle degrees	= 35	T	= 14 B12	
N	= 90	V1 degrees	= 45	
N1	= 25	Y	= 22	